

PRESSURE PLATE
(MOVABLE)

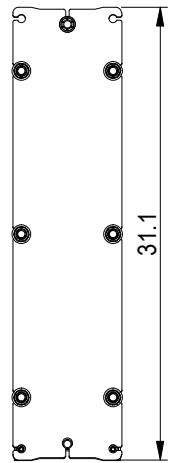

Space between pressure plate and supporting column should be kept free from fixed installations!

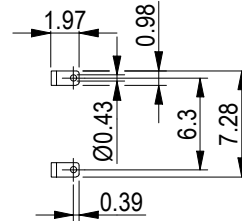
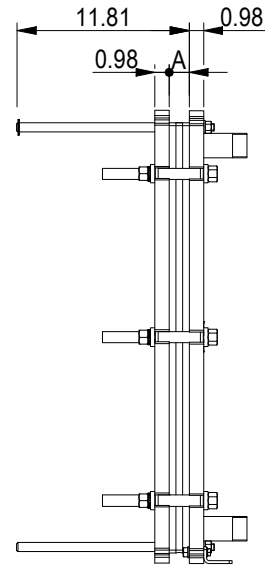

FRAME PLATE

All dimensions in inches

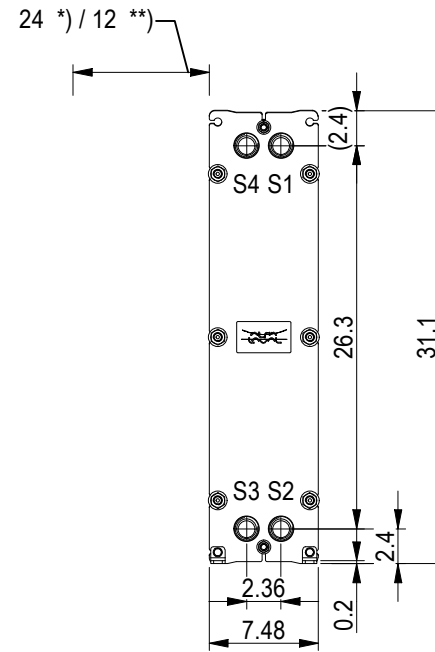

*) Recommended free space for opening and closing to be applied on both sides

**) Free space can be reduced to this distance on one of the sides

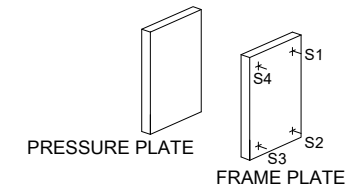
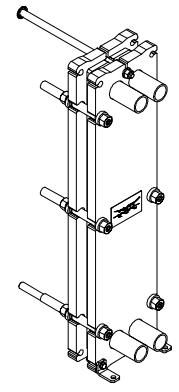

ASME B1.20.1 - 1 1/4-11.5 NPT, ALLOY 316, 101 mm
S1, S2, S3, S4 A-A:

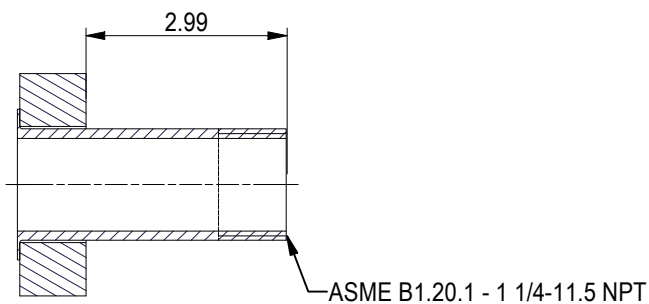
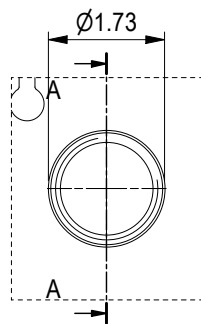

APPROX. OUTER DIMENSIONS	
LENGTH	12.2 in
WIDTH	7.9 in
HEIGHT	31.5 in
APPROX. WEIGHTS	
NET WEIGHT, EMPTY	136 lb
WEIGHT FULL OF WATER	139 lb
PLATE MATERIAL	ALLOY 316
PLATE THICKNESS	0.5 mm
GASKET	NBRP Clip-on

CHANNEL ARRANGEMENT 1*4 ML / 1*5 MH

NO. OF UNITS 1

null GPM
null GPM



www.alfalaval.com

DRAWING
GASKETED PLATE HEAT EXCHANGER

TL3-BFG

ASME
Code Section VIII Div.1

MAWP 145 psi at 150.1 °F
MDMT 32.0 °F at 145 psi
Designed and constructed in accordance with the 2019 ASME Code.

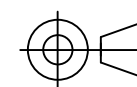

8240171407
TL3-BFG, 10 plates

Do not use this drawing for foundation bolting or piping layout

DATE 6/1/22
REVISION 0